

**Features**

- SiC Merged Pin Schottky
- High Frequency Operation
- No Reverse Recovery Current
- Qualified according to JEDEC criteria

**Product Summary**

$V_R$	<b>1200 V</b>
$I_{F\ typ}$	<b>5 A</b>

**Applications**

- Boost PFC Rectifier
- Solar Inverters
- Industrial motor drives

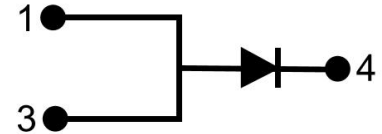
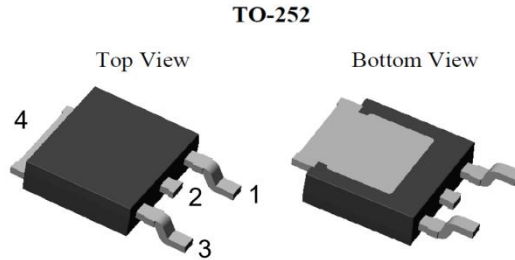
**Package Pin-Out Configuration**

Part No	Marking	Package	Packing	Qty
BSC120S05D	BSC120S05D	TO-252	Reel	2500PCS

**Absolute Maximum Ratings (at  $T_c = 25^\circ\text{C}$ , unless otherwise specified)**

Parameter	Symbol	Value	Unit
Peak reverse voltage	$V_R$	1200	V
Repetitive peak reverse voltage	$V_{RRM}$	1200	V
Continues forward current for $R_{th(j-c,max)}$			
TC = 155° C, D=1		5	
TC = 135° C, D=1	$I_F$	9	A
TC = 25° C, D=1		15	
Surge non-repetitive forward current			
sine halfwave			
$T_C=25^\circ\text{C}$ , $t_p=10\text{ms}$	$I_{FSM}$	52	A
$T_C=150^\circ\text{C}$ , $t_p=10\text{ms}$		43	
Repetitive forward surge current			
sine halfwave			
$T_C=25^\circ\text{C}$ , $t_p=10\text{ms}$	$I_{FRM}$	28	A
$T_C=150^\circ\text{C}$ , $t_p=10\text{ms}$		23	
Non-repetitive peak forward current			
$T_C = 25^\circ\text{C}$ , $t_p=10\ \mu\text{s}$	$I_{F,max}$	455	A
$i^2t$ value			
$T_C = 25^\circ\text{C}$ , $t_p = 10\text{ms}$	$\int i^2 dt$	14.6	A <sup>2</sup> s
$T_C = 150^\circ\text{C}$ , $t_p = 10\text{ms}$		10.5	
Power dissipation( $T_C = 25^\circ\text{C}$ )	$P_{Tot}$	106	W
Operating temperature	$T_j$	-55 to +175	°C

Storage temperature	$T_{stg}$	-55 to +150	°C
Soldering temperature, wavesoldering only allowed at leads, 1.6mm (0.063 in.) from case for 10s	$T_{sold}$	260	°C

**Thermal Resistance**

Parameter	Symbol	Max	Unit
Thermal resistance, junction – case.	$R_{thJC}$	1.41	°C/W
Thermal resistance, junction – ambient(min. footprint)	$R_{thJA}$	64	°C/W

**Electrical Characteristic**
**Static Characteristic(at  $T_j = 25\text{ °C}$ , unless otherwise specified)**

Parameter	Symbol	Conditions	Value			Unit
			Min	Typ	Max	
DC blocking voltage	$V_{DC}$	$T_j = 25\text{ °C}$	1200			V
Forward voltage	$V_F$	$I_F = 5A, T_j = 25\text{ °C}$	-	1.4	1.5	V
		$I_F = 5A, T_j = 175\text{ °C}$	-	2.1		
Reverse current	$I_R$	$V_R=1200V, T_j=25\text{ °C}$	-	5	250	$\mu A$
		$V_R=1200V, T_j=175\text{ °C}$	-	20		

**Dynamic Characteristics(at  $T_j=25\text{ °C}$ , unless otherwise specified)**

Parameter	Symbol	Conditions	Value			Unit
			Min	Typ	Max	
Total capacitive charge	$Q_C$	$V_R=800V, T_j=150\text{ °C}$ $Q_C = \int_0^{V_R} C(V)dV$	-	34	-	nC
Total capacitance	C	$V_R=1\text{ V}, f=1\text{ MHz}$	-	379	-	pF
		$V_R=400\text{ V}, f=1\text{ MHz}$	-	25	-	
		$V_R=800\text{ V}, f=1\text{ MHz}$	-	20	-	
Capacitance stored energy	$E_C$	$V_R=800V$		9.5		$\mu J$

Typical Performance Characteristics

Fig 1. Forward Characteristics

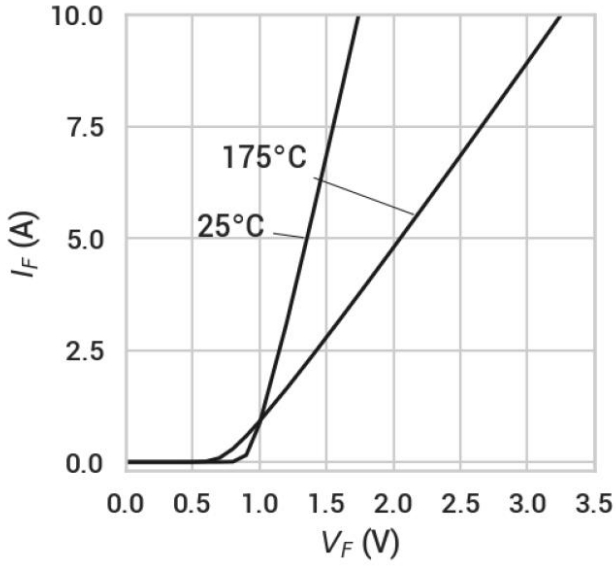

Fig 2. Reverse Characteristics

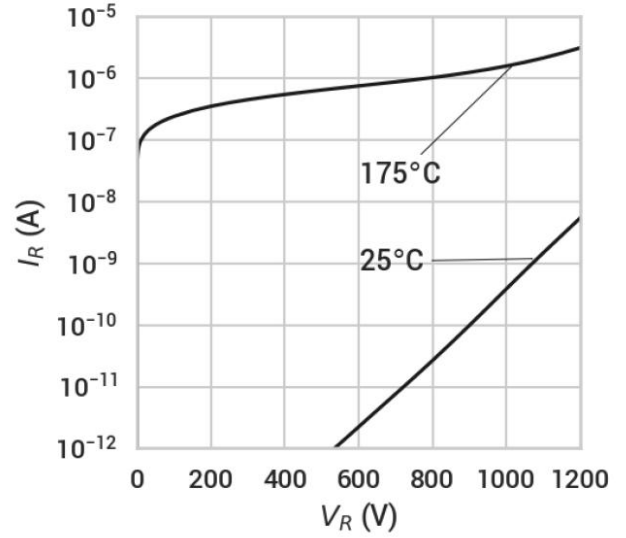

Fig 3. Capacitance vs Reverse Voltage

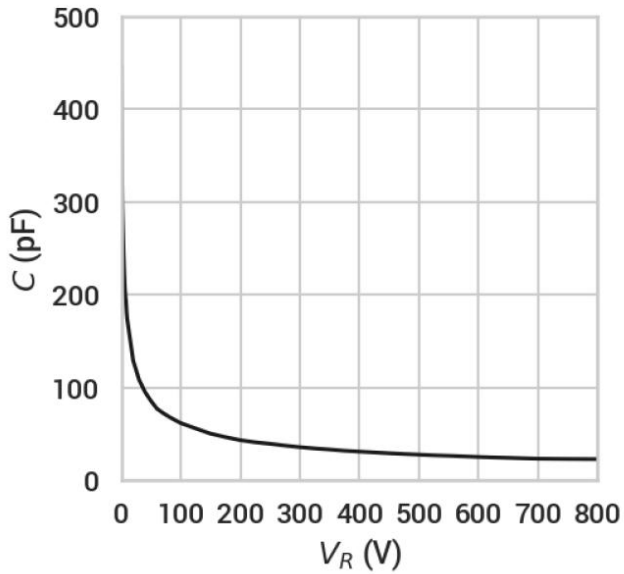
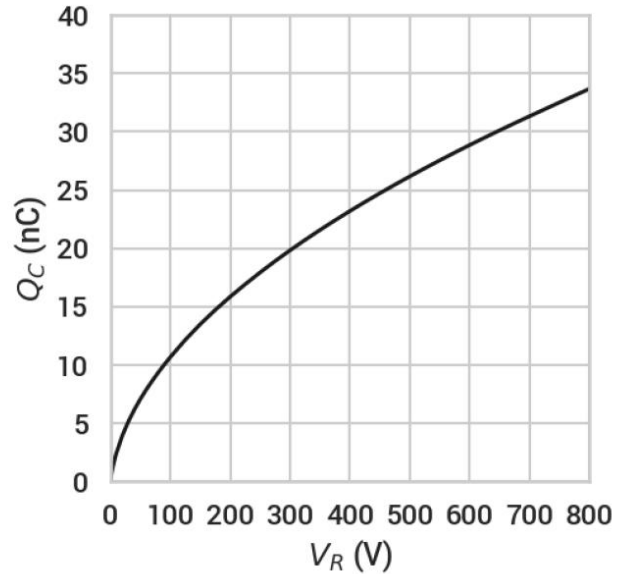
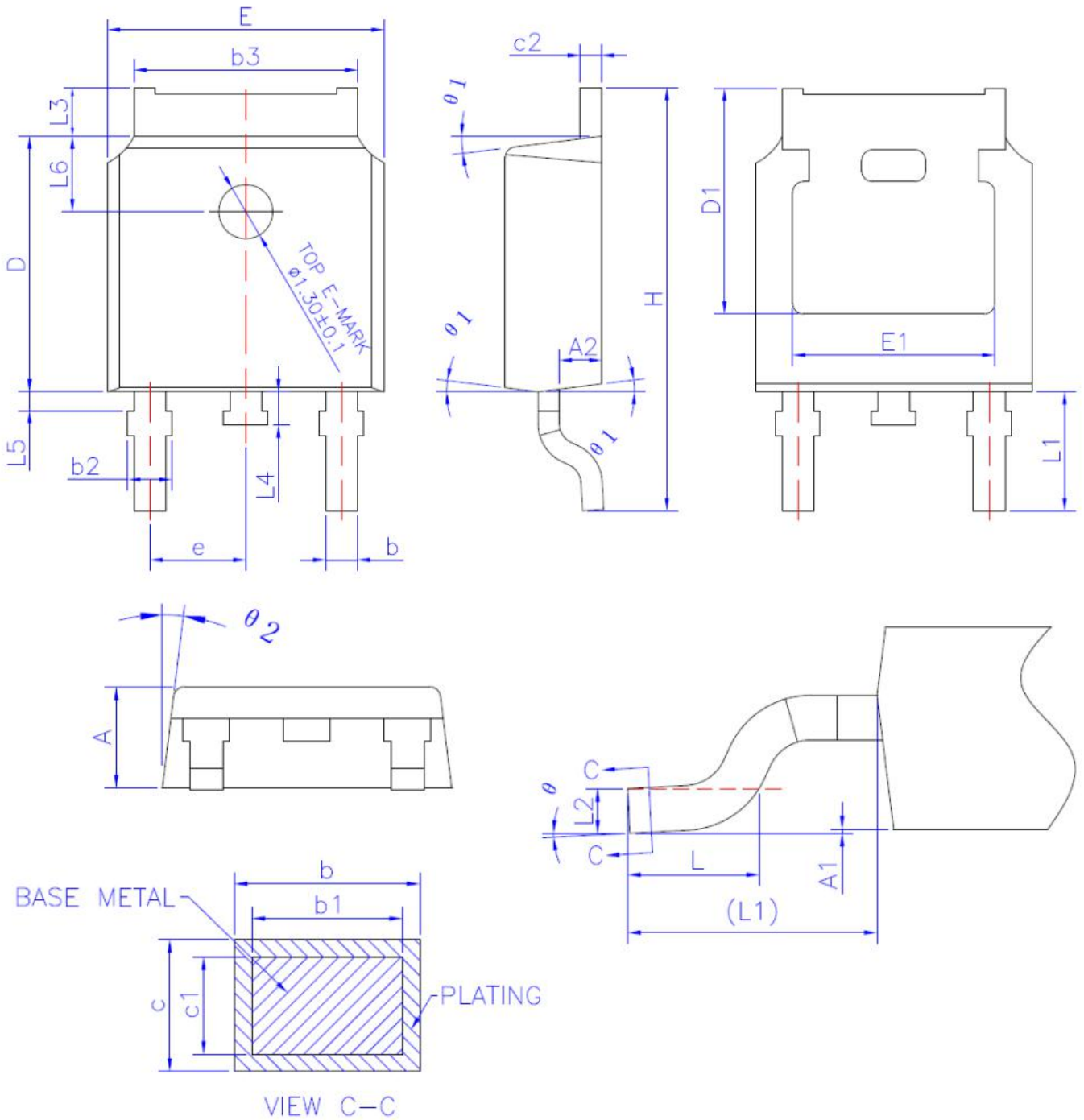

Fig 4. Stored Charge vs Reverse Voltage



Package Outline: TO-252



COMMON DIMENSIONS			
UNITS OF MEASURE=MILLIMETER			
SYMBOL	MIN	NOM	MAX
A	2.20	2.30	2.38
A1	0.00	-	0.10
A2	0.90	1.01	1.10
b	0.72	-	0.85
b1	0.71	0.76	0.81
b2	0.72	-	0.90
b3	5.13	5.33	5.46
c	0.47	-	0.60
c1	0.46	0.51	0.56
c2	0.47	-	0.60
D	6.00	6.10	6.20
D1	5.25	-	-
E	6.50	6.60	6.70
E1	4.70	-	-
e	2.186	2.286	2.386
H	9.80	10.10	10.40
L	1.40	1.50	1.70
L1	2.90 REF		
L2	0.508 BSC		
L3	0.90	-	1.25
L4	0.60	0.80	1.00
L5	0.15	-	0.75
L6	1.80 REF		
θ	0°	-	8°
θ1	5°	7°	9°
θ2	5°	7°	9°

**Revision History**

Revision	Date	Subjects (major changes since last revision)
1.0	2020/2/25	First release

**Disclaimer**

Unless otherwise specified in the datasheet, the product is designed and qualified as a standard commercial product and is not intended for use in applications that require extraordinary levels of quality and reliability, such as automotive, aviation/aerospace and life-support devices or systems.

Any and all semiconductor products have certain probability to fail or malfunction, which may result in personal injury, death or property damage. Customer are solely responsible for providing adequate safe measures when design their systems.

BeST reserves the right to improve product design, function and reliability without notice.