

Features

- SiC Merged Pin Schottky
- High Frequency Operation
- No Reverse Recovery Current
- Qualified according to JEDEC criteria

Applications

- Boost PFC Rectifier
- Solar Inverters
- Industrial motor drives

Product Summary

V_R	1200 V
I_F typ	15 A

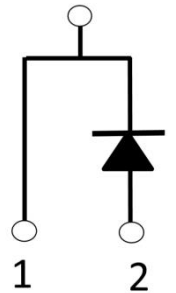

Part No	Marking	Package	Packing	Qty
BSC120S15K	BSC120S15K	TO-247-2L	Tube	20PCS

Absolute Maximum Ratings (at $T_c = 25^\circ\text{C}$, unless otherwise specified)

Parameter	Symbol	Value	Unit
Peak reverse voltage	V_R	1200	V
Repetitive peak reverse voltage	V_{RRM}	1200	V
Continues forward current for $R_{th(j-c,max)}$ $T_C = 152^\circ\text{C}$, $D=1$ $T_C = 135^\circ\text{C}$, $D=1$ $T_C = 25^\circ\text{C}$, $D=1$	I_F	15 20 31	A
Surge non-repetitive forward current sine halfwave $T_C=25^\circ\text{C}$, $t_p=10\text{ms}$ $T_C=150^\circ\text{C}$, $t_p=10\text{ms}$	I_{FSM}	98 80	A
Repetitive forward surge current sine halfwave $T_C=25^\circ\text{C}$, $t_p=10\text{ms}$ $T_C=150^\circ\text{C}$, $t_p=10\text{ms}$	I_{FRM}	58 40	A
Non-repetitive peak forward current $T_C = 25^\circ\text{C}$, $t_p=10\ \mu\text{s}$	$I_{F,max}$	1044	A
i^2t value $T_C = 25^\circ\text{C}$, $t_p = 10\text{ms}$ $T_C = 150^\circ\text{C}$, $t_p = 10\text{ms}$	$\int i^2 dt$	51 37	A^2s
Power dissipation($T_C = 25^\circ\text{C}$)	P_{Tot}	182	W
Operating temperature	T_j	-55 to +175	$^\circ\text{C}$

Storage temperature	T_{stg}	-55 to +150	°C
Soldering temperature, wavesoldering only allowed at leads, 1.6mm (0.063 in.) from case for 10s	T_{sold}	260	°C

Thermal Resistance

Parameter	Symbol	Max	Unit
Thermal resistance, junction – case.	R_{thJC}	1.0	°C/W
Thermal resistance, junction – ambient(min. footprint)	R_{thJA}	63	°C/W

Electrical Characteristic
Static Characteristic(at $T_j = 25\text{ °C}$, unless otherwise specified)

Parameter	Symbol	Conditions	Value			Unit
			Min	Typ	Max	
DC blocking voltage	V_{DC}	$T_j = 25\text{ °C}$	1200			V
Forward voltage	V_F	$I_F = 15\text{ A}, T_j = 25\text{ °C}$	-	1.4	1.6	V
		$I_F = 15\text{ A}, T_j = 175\text{ °C}$	-	2.3		
Reverse current	I_R	$V_R = 1200\text{ V}, T_j = 25\text{ °C}$	-	15	250	μA
		$V_R = 1200\text{ V}, T_j = 175\text{ °C}$	-	60		

Dynamic Characteristics(at $T_j = 25\text{ °C}$, unless otherwise specified)

Parameter	Symbol	Conditions	Value			Unit
			Min	Typ	Max	
Total capacitive charge	Q_C	$V_R = 800\text{ V}, T_j = 150\text{ °C}$ $Q_C = \int_0^{V_R} C(V) dV$	-	86	-	nC
Total capacitance	C	$V_R = 1\text{ V}, f = 1\text{ MHz}$	-	1150	-	pF
		$V_R = 400\text{ V}, f = 1\text{ MHz}$	-	75	-	
		$V_R = 800\text{ V}, f = 1\text{ MHz}$	-	54	-	
Capacitance stored energy	E_C	$V_R = 800\text{ V}$		24.3		μJ

Typical Performance Characteristics

Fig 1. Forward Characteristics

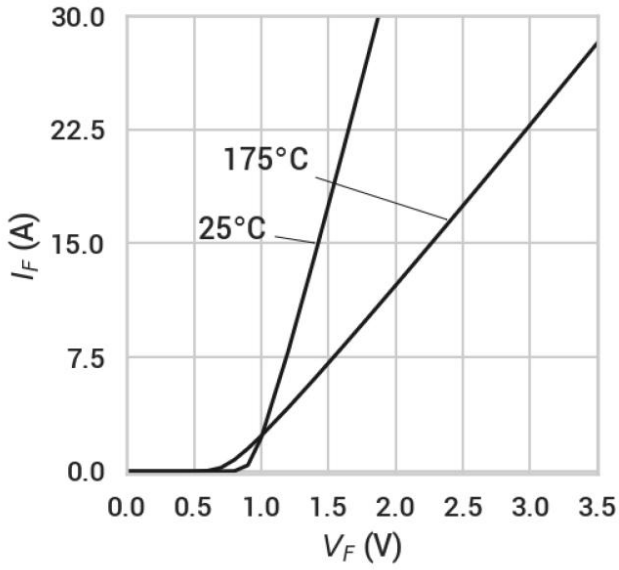

Fig 2. Reverse Characteristics

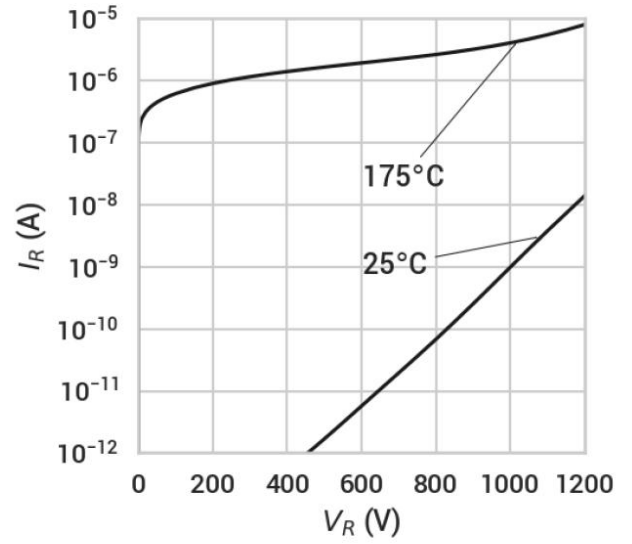

Fig 3. Capacitance vs Reverse Voltage

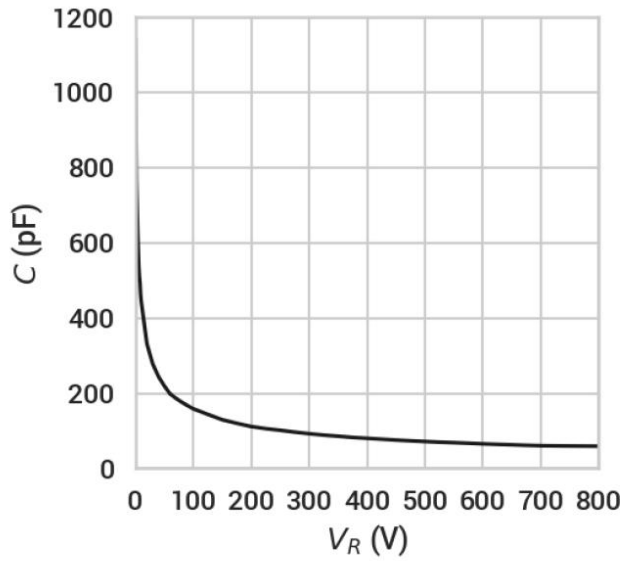
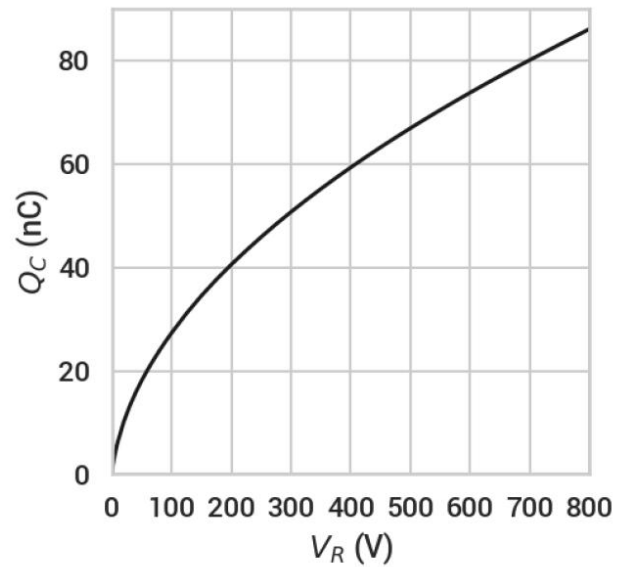
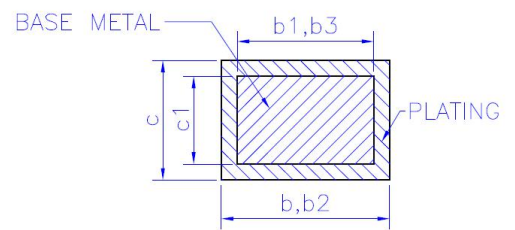
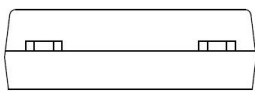
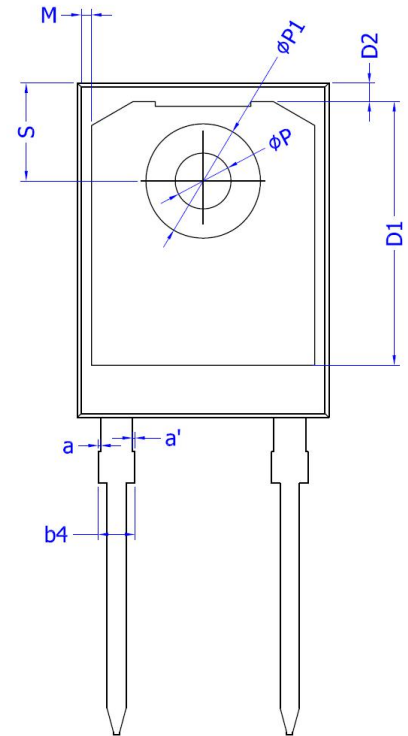
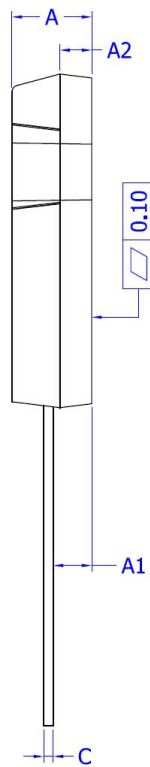
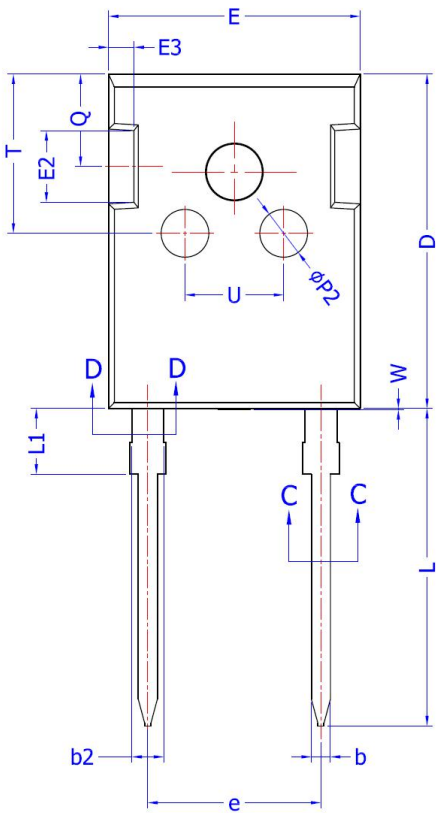

Fig 4. Stored Charge vs Reverse Voltage



Package Outline: TO-247-2L



SECTION C-C, D-D

NOTES:

ALL DIMENSIONS REFER TO JEDEC STANDARD TO-247 AD
DO NOT INCLUDE MOLD FLASH OR PROTRUSIONS.

EJECTION MARK DEPTH $0.10^{+0.15}_{-0.10}$

COMMON DIMENSIONS
 (UNITS OF MEASURE =MILLIMETER)

SYMBOL	MIN	NOM	MAX
A	4.90	5.00	5.10
A1	2.31	2.41	2.51
A2	1.90	2.00	2.10
a	0	---	0.15
a'	0	---	0.15
b	1.16	---	1.26
b1	1.15	1.2	1.22
b2	1.96	---	2.06
b3	1.95	2.00	2.02
b4	---	---	2.25
c	0.59	---	0.66
c1	0.58	0.60	0.62
D	20.90	21.00	21.10
D1	16.25	16.55	16.85
D2	1.05	1.17	1.35
E	15.70	15.80	15.90
E2	4.40	4.50	4.60
E3	1.50	1.60	1.70
e		10.872 BSC	
L	19.80	19.92	20.10
L1	---	---	4.30
M	0.35	---	0.95
P	3.40	3.50	3.60
P1	7.00	---	7.40
P2	2.40	2.50	2.60
Q	5.60	---	6.00
S	6.05	6.15	6.25
T	9.80	---	10.20
U	6.00	---	6.40
W	0	---	0.15

Revision History

Revision	Date	Subjects (major changes since last revision)
1.0	2020/2/25	First release

Disclaimer

Unless otherwise specified in the datasheet, the product is designed and qualified as a standard commercial product and is not intended for use in applications that require extraordinary levels of quality and reliability, such as automotive, aviation/aerospace and life-support devices or systems.

Any and all semiconductor products have certain probability to fail or malfunction, which may result in personal injury, death or property damage. Customer are solely responsible for providing adequate safe measures when design their systems.

BeST reserves the right to improve product design, function and reliability without notice.